

Article number: 0105032
 Description: Retaining ring AV 16
 Note: Fitted with ZGA pliers

Measures

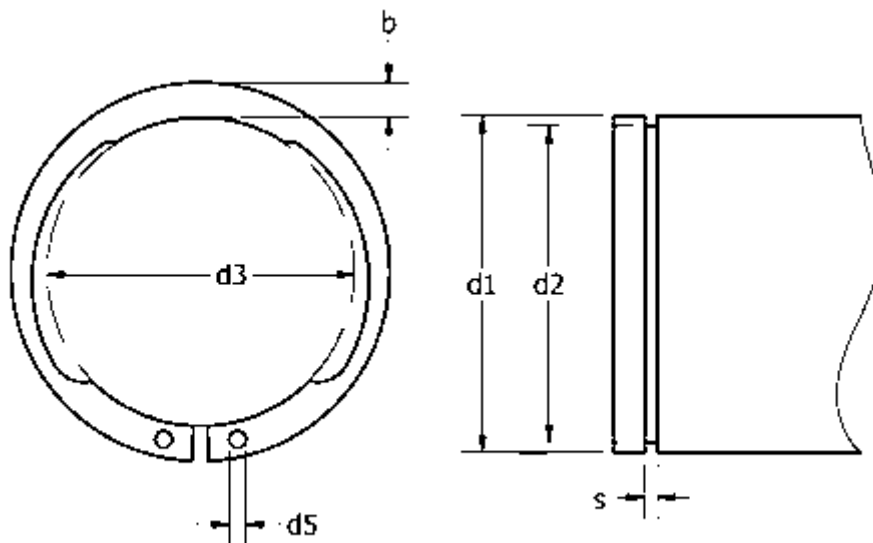

AN mm ²	= 8.9	FRg kN	= 2.5	t	= 0.40
b	= 2.3	FR kN	= 7.0	tol	= -0.06
d1	= 16	g	= 1.0	tol	= -0.11
d2	= 15.2	K kN-mm	= 18.7	tol	= +0,10-0,36
d3	= 14.70	m min	= 1.10	tol	= 0.1
d5 min	= 1.3	n abl x 1000	= 45	Tong	= ZGA-0
Description	= AV 16	s	= 1.00	Weight kg/1000	= 0.72
FN kN	= 1.48	Side power N at I2	= 1.2		